

PCT-712ET

70 SUPERLOTUS TOP ELECTRIC BOILING UNIT - TOP



Boiling unit threephase - N. 6 plates
(included 1 Head end filler strip mod.TPA-7)



Construction -Fabricated using CrNi 18/10 AISI 304 grade Stainless Steel Scotch-Brite Satin polish Finish, incorporating 2 mm thick worktop, rounded edges, chromed details and rear splash back. Knobs with waterproof grades IPX5. Model - Professional Electric Boiling Hob. Cast Iron square or round hot plates with steel border seals, seven position switch and temperature limiter. Ceramic glass tops with radiant heat hot plates and warning lights for residual heat. Maintenance - All serviceable parts are accessible by the easy removal of front control panel. Fittings - Appliance is supplied with adjustable feet.

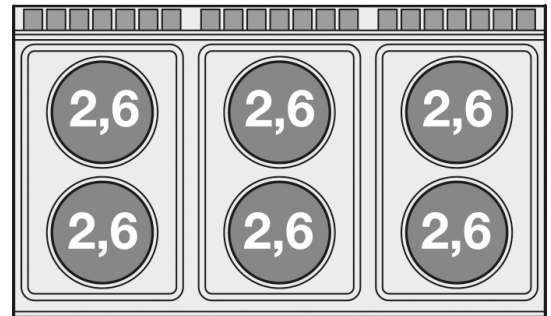

ITALIAN CULINARY ART

The pictures are purely representative. The manufacturer reserves the right to modify the technical data and models without previous notice.

PCT-712ET

70 SUPERLOTUS TOP
ELECTRIC BOILING UNIT - TOP

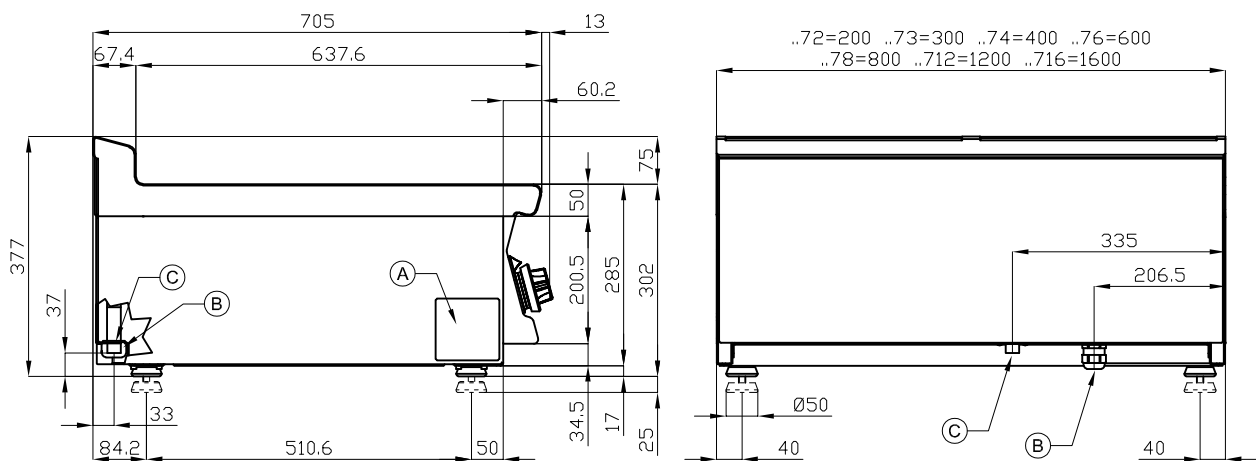

A	Data plate		B	Electrical connection	
---	------------	--	---	-----------------------	--

MODEL: PCT-712ET
DIMENSIONS: cm. 120x 70,5x 28h
ELECTRIC POWER: 15,6 kW
VOLTAGE: 400V~3N / 230V~3
FREQUENCY: 50/60 Hz



kg: 82
m³: 0.511
mm: 1230x770x540

BUY LOTUS BUY ITALY

The pictures are purely representative. The manufacturer reserves the right to modify the technical data and models without previous notice.



LOTUS S.P.A. Via Calmaor, 46
31020 San Vendemiano(TV) - Italy
Tel. + 39 0438 778020 / 778468
Fax + 39 0438 778277
www.lotuscookers.it - lotus@lotuscookers.it